

Metso

Proven reliability and performance

Nordberg[®] C Series[™] jaw crushers





Nordberg® C Series™ jaw crushers

Maximum productivity with low operating costs

Nordberg® C Series™ jaw crushers are engineered for the toughest feed materials in the primary crushing stage. They deliver the crushing performance you need, and have proven their reliability and productivity in well over 10,000 quarrying, mining, recycling and industrial minerals applications since 1975.

C Series jaw crushers have a strong pinned and bolted, non-welded frame construction and the highest power ratings in each size class, which brings benefits to stationary, underground and mobile crushing applications. They are designed to the highest safety standards to make the use and maintenance as easy as possible. Metso's in-house expertise and close cooperation with our suppliers and customers enables continuous development of our jaw crushers.

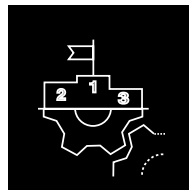

Proven reliability and performance

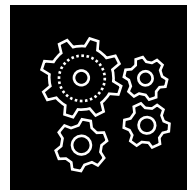

Pinned and bolted, non-welded frame construction

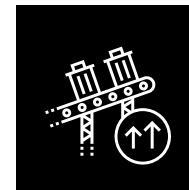

Long-term investment

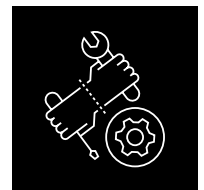

Safe and easy to operate and maintain



Contents

Nordberg® C Series™ jaw crushers	2
Maximum productivity	2
Pinned and bolted, non-welded frame construction	4
Proven performance	6
Safe and effortless operation	8
IC10C crusher automation	9
Designed for the toughest crushing applications	10
Technical specifications	11
Crusher throughput capacity, scalped feed material	12
Crusher throughput capacity, non-scalped material	14
Aftermarket parts and services	16
Proven case studies	18

Pinned and bolted, non-welded frame construction

Nordberg® C Series™ jaw crushers are based on pinned and bolted, non-welded frame construction. This design principle contributes to their excellent fatigue life and strength, which has been proven in FEM calculations, extensive simulations

and in the toughest real-life applications. This, combined with high-quality steel casting design and large size spherical roller bearings, delivers the reliability that Nordberg C Series jaw crushers are known for.

The Nordberg® C Series™ jaw crusher product family includes altogether ten models:

- C80™
- C96™
- C106™
- C117™
- C120™
- C130™
- C150™
- C160™
- C200™
- C3054™



Long-term investment

At Metso, we know that C Series jaw crushers are long-term investments for our customers. That's why we have designed them for dependable productivity over their entire lifetime, year after year. The key to their proven reliability and high uptime is their revolutionary pinned and bolted design without welded seams. This, combined with swift installation and easy maintenance, provides high availability to improve profitability and shorten the pay-back time of the investment.

Thanks to Metso's experience and comprehensive testing at customer sites, the critical parts are protected against wear by long-lasting wear items. For example, pitman eye protection protects the bearings and the pitman casting from impacts caused by really coarse feed, and it is also effortless to change. Even the main frame components are changeable thanks to the pinned and bolted design, prolonging the potential lifetime of the jaw crusher.

Modular design enables easy installation

Nordberg C Series jaw crushers are modular for quick, easy installation and commissioning in new plants and when replacing old jaw crushers. This minimizes on-site engineering and fabrication, saves time, and reduces installation and structural costs. The integral motor base reduces space requirements and allows standard flywheel guards to be used, eliminating the need for local engineering and fitting. The optional feed chute can be attached during installation.

C Series jaw crushers are also easy to install in underground mining applications as the modular design allows them to be dismantled for transportation in tight spaces. Mounting the crusher does not require anchor bolts. This is due to our unique solution where the crusher is standing on its own weight, and vibrations are absorbed by rubber dampers under support brackets. They are also engineered to deliver the maximum productivity at the lowest operating costs.



Aggregates



- Outstanding fatigue strength
- Great in casting engineering
- Wide range of options

Universal crushers for quarrying and mining applications

- High throughput
- Easy maintenance
- Application flexibility

Mining



- High material intake capacity
- Premium quality components
 - Easy installation

Nordberg® C Series™: Proven Performance

Nordberg® C Series™ jaw crushers have proven to be reliable and productive in thousands of mining, quarrying, recycling and industrial applications with up to 11,000 jaw crusher installations since 1975.

Developed to crush the hardest ores and rocks, jaw crushers also perform outstandingly with less demanding materials. In addition to the stationary jaw crushers, many models are also available as mobile or portable versions.



- Full utilization of the feed opening
- Maximized capacity with horizontally directed stroke
- Longer wear part lifetime due to less attrition

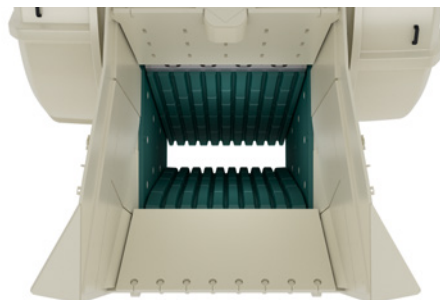

Excellent material intake capability

Nordberg C Series jaw crushers have excellent material intake capacity because the feed opening has the right width to depth ratio. This ensures that rocks enter the cavity without uptime-consuming bridging. C Series crushers can handle very coarse feed material, thus reducing the need for blasting and hammering. An optional feed chute is available, which is designed for uninterrupted material flow from the feeder straight into the crusher cavity.

Conventional jaw crusher design:

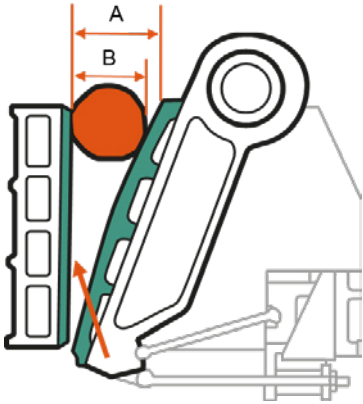

Nordberg C Series jaw crusher:

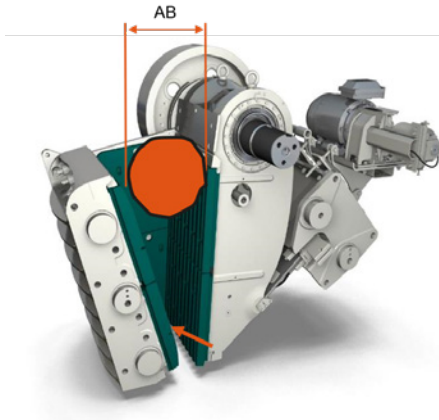

Aggressive pitman motion

Getting the kinematics of the movable jaw dies right is an important aspect when considering the performance of a jaw crusher. Our industry-leading stroke is amplified from top to bottom, being at its longest in the lower parts of the cavity. This increases the open area between the jaw dies allowing the material to have more space to get out, while also enabling inter-particle crushing. This design principle results in an increase in both the capacity and the reduction ratio.

Optimal nip angle ensures excellent bite in the cavity

The correct nip angle between the movable and fixed jaw dies ensures good bite and material flow down, even with slippery feed material. It also reduces wear on the jaw dies, reducing operating costs. With a good grip, the jaw crusher can crush rocks efficiently through the entirety of the cavity, and the nip angle can be further improved with an intermediate plate.

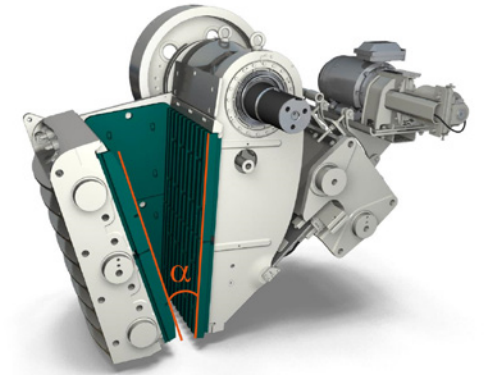

Optimal design reduces operational and wear costs

Metso offers a wide selection of different manganese jaw die profiles and thicknesses to achieve the perfect match for applications including quarrying, mining, aggregates, and recycling of demolition material and asphalt. We use the optimum tooth spacing and profile, jaw thickness and alloys for each application to ensure reliable, long lasting performance. Metso jaw die fixing components are extremely durable and can be quickly replaced, reducing wear part-related costs even further. Metso also develops custom jaws for special applications. Special cheek plates are also available.



Nordberg® C Series™: Safe and effortless operation and maintenance

The setting of the Nordberg C Series jaw crusher can be adjusted with two wedges without shim plates. The adjustment system is mechanically moved as standard, and the fully automatic hydraulic option is available to make the wedge movement even faster and safer. Other safety-enhancing features are the lightweight yet impact resistant composite guards for the flywheels and V-belts.

Maintenance and operation can also be enhanced with an optional motor base integrated into the rear frame. This lets the motor move in sync with the crusher, reducing the time you need to spend on V-belt alignment and tensioning. In addition, the greasing of the crusher can be centralized by a distributor or even automated with a greasing pump.

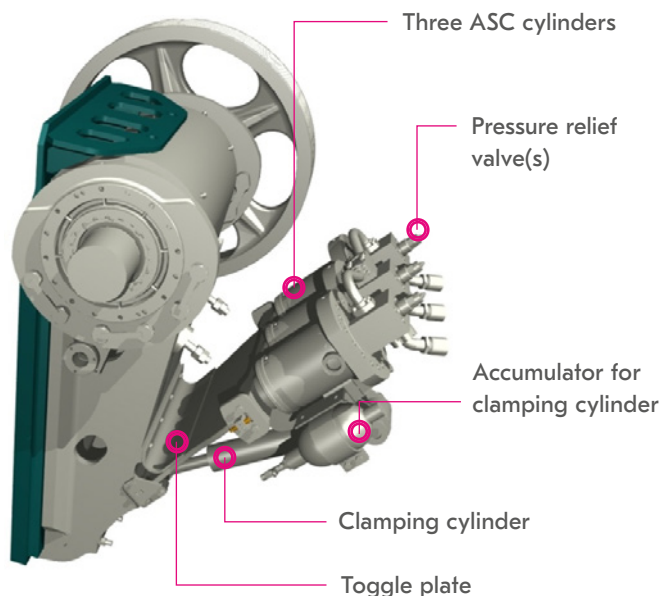

Active Setting Control (ASC)

Active Setting Control (ASC) is an optional accessory for the C96™, C106™, C117™ and C120™ models. This greatly enhances the crusher's performance in hard applications with frequent uncrushable objects, such as in recycling or slag applications. It also significantly improves uptime as it lets you adjust settings under a full crushing load.

With ASC, combined with IC10C, the crusher setting opens automatically when it encounters uncrushable material and returns back to the original setting, enabling it to continue crushing seamlessly.

ASC technology protects the crusher's critical components from damage with three cylinders built inside the rear frame. The unique three cylinder concept prevents the pitman bearings from twisting and ASC also includes a toggle plate for optimum jaw crusher protection.

IC10C crusher automation

Nordberg C Series jaw crushers are available with Metso IC10C crusher automation which controls and monitors crusher and ancillary equipment helping to achieve the best performance, protection and safety, and to maximize uptime. The IC10C provides constant throughput by full control of the crushing process, as well as condition and data monitoring together with many sensors available.

Crusher automation is easy to install and is provided as complete package including interface to all selected options such as crusher motor starter, hydraulic powerpack, greasing unit and crushers sensors.

Standard package provides control logic also for feeder and discharge conveyor. Optionally with crushing station module the automation can provide further primary station automation including further conveyor control options, dust remover control, water spray control, magnetic separator control and many others.

The web-based Remote User-Interface is easy to use and enables remote control for improved operator safety and comfort. Remote control enables the operator to access all the real-time process information in centralized and safe control room with ability to adjust CSS and feed rate.

IC10C can be connected to customer's plant wide automation by using standard communication protocols. Metso Metrics fleet management system provides key performance indicators remotely anywhere anytime helping to monitor equipment utilization, plan upcoming service events with maintenance calendar and to have notifications of critical events.



- Cost efficiency
- Minimizes on-site engineering
- Easy installation



Nordberg® C Series™ jaw crushers

Proven reliability and performance

Nordberg® C Series™ jaw crushers are designed to handle the toughest feed materials in the primary crushing stage. They have proven their performance in at least 10,000 reference cases since 1975, in applications including mining, quarrying, recycling and industrial minerals. They have the highest power ratings in each size class thanks to their strong pinned and bolted frame, making them ideal for stationary, underground and mobile crushing applications.

The feed intake can handle even the coarsest materials

- A pitman eye protection plate gives extra protection

Protection plates behind the jaw dies protect the steel castings against wear

Continuous development of high quality castings with long ribs in two directions

Easy to replace fixing components for jaw dies

The four large and identical spherical roller bearings are labyrinth sealed

- Only the top brands are used

Support brackets and dampers absorb vibrations

- No anchor bolts are needed for installation

The setting can be adjusted with two wedges without shim plates

- Adjustments are mechanical as standard
- A fully automatic hydraulic option is also available to make adjustments even faster and safer



Heavy-duty design

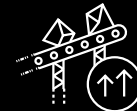

Pinned and bolted, non-welded frame construction



Pinned and bolted, non-welded frame construction



Safe and easy to maintain

Technical specifications Nordberg® C Series™ jaw crushers

	C80™	C96™	C106™	C117™	C120™	C130™	C150™	C160™	C200™	C3054™
Maximum installed power	75 kW (100 hp)	90 kW (125 hp)	110 kW (150 hp)	132 kW (175 hp)	160 kW (200 hp)	185 kW (250 hp)	200 kW (300 hp)	250 kW (350 hp)	400 kW (500 hp)	160 kW (200 hp)
Speed	350 rpm	330 rpm	280 rpm	260 rpm	230 rpm	220 rpm	220 rpm	220 rpm	200 rpm	260 rpm
Basic crusher weight *)	7 650 kg 16 870 lbs	10 150 kg 22 380 lbs	15 650 kg 34 502 lbs	21 150 kg 46 630 lbs	27 990 kg 61 710 lbs	40 150 kg 88 516 lbs	50 950 kg 112 330 lbs	76 300 kg 168 213 lbs	124 000 kg 273 373 lbs	26 500 kg 58 420 lbs
Operational crusher weight **)	9 340 kg 20 590 lbs	12 260 kg 27 030 lbs	18 510 kg 40 810 lbs	23 600 kg 52 030 lbs	31 690 kg 69 860 lbs	46 300 kg 102 070 lbs	59 440 kg 131 100 lbs	87 260 kg 192 400 lbs	147 110 kg 324 320 lbs	30 140 kg 66 450 lbs
Minimum closed side setting	40 mm (1½")	60 mm (2¾")	70 mm (2¾")	70 mm (2¾")	70 mm (2¾")	100 mm (4")	125 mm (5")	150 mm (6")	175 mm (7")	70 mm (2¾")
Maximum closed side setting	175 mm (7")	175 mm (7")	200 mm (8")	200 mm (8")	175 mm (7")	250 mm (10")	250 mm (10")	300 mm (12")	300 mm (12")	200 mm (8")
Nominal feed opening										
Width ***)	800 mm (32")	930 mm (37")	1 060 mm (42")	1 150 mm (45")	1 200 mm (47")	1 300 mm (51")	1 400 mm (55")	1 600 mm (63")	2 000 mm (79")	1380 mm (54")
Depth ***)	510 mm (20")	580 mm (23")	700 mm (28")	760 mm (30")	870 mm (34")	1 000 mm (39")	1 200 mm (47")	1 200 mm (47")	1 500 mm (59")	760 mm (30")
Estimated maximum feed size ****)	410 mm (16")	460 mm (18")	560 mm (22")	610 mm (24")	700 mm (28")	800 mm (32")	960 mm (38")	960 mm (38")	1200 mm (47")	610 mm (24")

*) Crusher without options ***) Actual feed opening depths are cavity specific
) Crusher with options **) This dimension refers to the middle dimension of the estimated maximum rock size that can be fed to the crusher with new jaw dies.



IC10C crusher automation for crushing process optimization and monitoring.

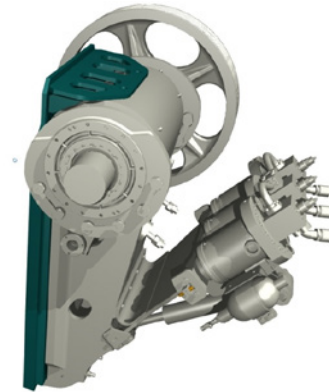

Active Setting Control (ASC) for C96, C106, C117 and C120 to enhance performance & protect the crusher in hard applications with frequent uncrushable objects.



Service tools for safe maintenance are part of the standard delivery

Nordberg® C Series™ jaw crushers

Technical specifications

	C80™	C96™	C106™	C117™	C120™	C130™	C150™	C160™	C200™	C3054™
Crusher throughput capacity, scalped feed material										
Closed side setting										
Capacity										
40 mm	55 - 75									
1½"	60 - 80									
50 mm	65 - 95									
2"	75 - 100									
60 mm	80 - 110	105 - 135								
2¾"	90 - 120	115 - 150								
70 mm	95 - 135	125 - 155	150 - 185	165 - 205	175 - 240					210 - 270
2¾"	110 - 145	135 - 170	160 - 205	180 - 225	195 - 265					230 - 295
80 mm	110 - 150	140 - 180	165 - 215	180 - 235	195 - 270					240 - 300
3½"	120 - 165	155 - 200	185 - 240	200 - 260	215 - 295					260 - 330
90 mm	125 - 175	160 - 200	190 - 235	205 - 255	210 - 305					260 - 330
3½"	140 - 190	175 - 220	205 - 260	225 - 280	235 - 330					285 - 360
100 mm	140 - 190	175 - 225	205 - 265	225 - 285	235 - 325	270 - 369				285 - 365
4"	150 - 210	195 - 250	230 - 295	245 - 315	260 - 360	297 - 406				315 - 400
125 mm	175 - 245	220 - 280	255 - 325	270 - 345	285 - 395	325 - 446	340 - 470			345 - 435
5"	195 - 270	240 - 310	280 - 360	295 - 380	315 - 435	358 - 491	375 - 515			375 - 480
150 mm	210 - 290	265 - 335	305 - 385	320 - 405	340 - 475	380 - 523	400 - 555	430 - 610		405 - 515
6"	230 - 320	290 - 370	335 - 428	350 - 450	375 - 515	418 - 576	440 - 610	475 - 670		445 - 565
175 mm	245 - 335	310 - 390	355 - 450	370 - 465	385 - 540	435 - 600	460 - 635	495 - 695	630 - 890	465 - 595
7"	270 - 370	340 - 430	390 - 495	405 - 515	430 - 595	479 - 661	505 - 700	545 - 765	695 - 980	515 - 650
200 mm			395 - 500	410 - 520		490 - 677	520 - 720	560 - 790	710 - 1000	530 - 670
8"			445 - 560	460 - 580		539 - 746	570 - 790	615 - 870	780 - 1100	580 - 740
225 mm						545 - 754	580 - 800	625 - 880	785 - 1105	
9"						600 - 830	640 - 880	685 - 965	860 - 1215	
250 mm						600 - 831	640 - 880	685 - 965	865 - 1215	
10"						661 - 915	705 - 970	755 - 1060	950 - 1340	
275 mm								745 - 1055	940 - 1320	
11"								820 - 1160	1030 - 1455	
300 mm								815 - 1145	1015 - 1435	
12"								895 - 1260	1120 - 1575	

Mtph
Stph

Benefits of primary crushing with scalping

Smaller closed side settings may be possible depending on application and end product requirements. For a performance estimation for your specific application, please simulate with the Bruno™ process simulation program or contact Metso.

The figures on the left represent the crusher capacities, which are based on a feed material with an average specific gravity of 2.7 t/m³, a maximum feed size that will enter the crusher without bridging and material finer than the crusher closed side setting removed.

The capacities may vary depending on the feeding method and on feed characteristics such as gradation, bulk density and moisture, clay content and crushability. Measurement of the crusher's closed side setting varies depending on the jaw profile that is being used and this has an impact on the crusher's capacity and product gradation.

The following factors will enhance crusher capacity and performance:

- 1: Proper selection of the jaws
- 2: Proper feed gradation
- 3: Controlled feed rate
- 4: Sufficient feeder capacity and width
- 5: Adequate crusher discharge area
- 6: Discharge conveyor sized to convey maximum crusher capacity

Benefits

- Better total capacity in all applications
- Better wear part wear profile
- Longer lifetime of wear parts
- Better total economy
- Lower risk of packing

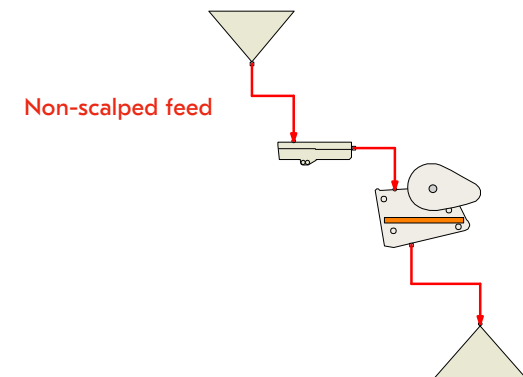
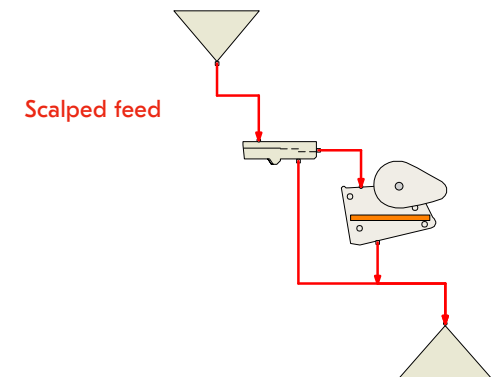

Nordberg® C Series™ jaw crushers

Technical specifications

	C80™	C96™	C106™	C117™	C120™	C130™	C150™	C160™	C200™	C3054™
Crusher throughput capacity, non-scalped feed material										
40 mm	63 - 86									
1½"	72 - 98									
50 mm	65 - 95									
2"	84 - 122									
60 mm	92 - 127	121 - 155								
2¾"	102 - 140	134 - 171								
70 mm	109 - 155	144 - 178	173 - 213	190 - 236	205 - 277					242 - 311
2¾"	120 - 170	158 - 195	191 - 235	209 - 260	225 - 304					267 - 341
80 mm	133 - 179	156 - 212	190 - 242	209 - 265	237 - 321					279 - 338
3½"	145 - 196	171 - 231	209 - 267	230 - 292	259 - 350					299 - 371
90 mm	156 - 210	182 - 246	215 - 275	236 - 300	269 - 365					299 - 388
3½"	169 - 229	198 - 267	237 - 303	260 - 331	293 - 396					329 - 426
100 mm	179 - 242	209 - 283	240 - 313	263 - 338	303 - 409	316 - 428				333 - 433
4"	199 - 270	234 - 316	265 - 345	290 - 373	338 - 458	353 - 478				373 - 474
125 mm	241 - 327	281 - 380	306 - 414	335 - 445	391 - 529	407 - 551	420 - 568			428 - 561
5"	270 - 365	313 - 424	337 - 456	369 - 491	437 - 591	455 - 616	469 - 635			469 - 620
150 mm	309 - 417	357 - 483	387 - 523	415 - 555	484 - 654	503 - 681	521 - 705	599 - 811		525 - 706
6"	345 - 467	399 - 540	427 - 577	457 - 612	541 - 731	562 - 761	582 - 788	670 - 906		581 - 768
175 mm	380 - 514	438 - 592	472 - 638	500 - 670	581 - 800	605 - 819	627 - 849	722 - 976	917 - 1 241	628 - 857
7"	425 - 575	489 - 662	520 - 703	551 - 739	650 - 882	676 - 915	701 - 949	807 - 1 091	1 025 - 1 387	701 - 933
200 mm			562 - 760	590 - 800		711 - 963	739 - 999	849 - 1 149	1 082 - 1 464	763 - 1031
8"			619 - 838	650 - 882		795 - 1 076	826 - 1 117	949 - 1 284	1 209 - 1 636	820 - 1125
225 mm						822 - 1 112	855 - 1 157	983 - 1 331	1 255 - 1 699	
9"						919 - 1 243	956 - 1 293	1 099 - 1 487	1 403 - 1 989	
250 mm						937 - 1 267	975 - 1 319	1 121 - 1 517	1 437 - 1 898	
10"						1 047 - 1 416	1 090 - 1 474	1 253 - 1 695	1 605 - 2 172	
275 mm								1 264 - 1 710	1 625 - 2 199	
11"								1 413 - 1 911	1 816 - 2 457	
300 mm								1 411 - 1 909	1 820 - 2 462	
12"								1 577 - 2 133	2 034 - 2 752	

Nordberg® C Series™ jaw crushers

Benefits of primary crushing without scalping

Smaller closed side settings may be possible depending on application and end product requirements. For a performance estimation for your specific application, please simulate with the Bruno™ process simulation program or contact Metso. The figures on the left represent the crusher capacities, which are based on a feed material with an average specific gravity of 2.7 t/m³, a maximum feed size that will enter the crusher without bridging and material finer than the crusher closed side setting removed. The capacities may vary depending on the feeding method and on feed characteristics such as gradation, bulk density and moisture, clay content and crushability. Measurement of the crusher's closed side setting varies depending on the jaw profile that is being used and this has an impact on the crusher's capacity and product gradation.

The following factors will enhance crusher capacity and performance:

- 1: Proper selection of the jaws
- 2: Proper feed gradation
- 3: Controlled feed rate
- 4: Sufficient feeder capacity and width
- 5: Adequate crusher discharge area
- 6: Discharge conveyor sized to convey maximum crusher capacity

Benefits:

- Simpler flowsheet
- More compact lay-out
- Preferred in some mining applications

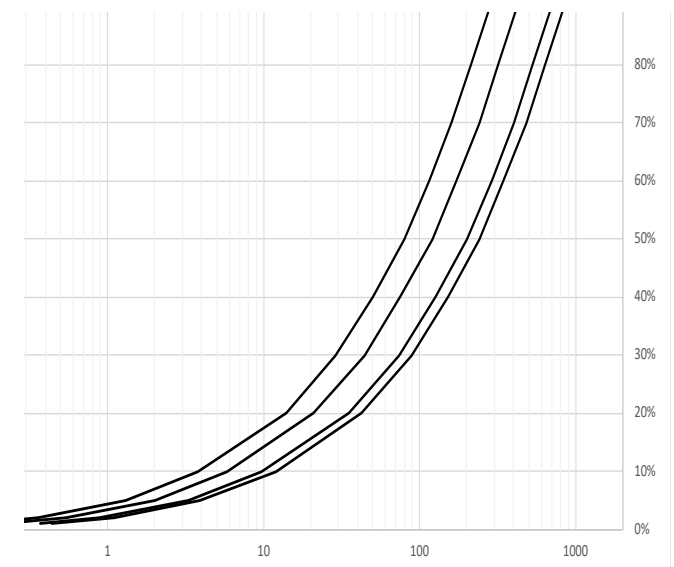

High-quality jaw crusher parts are the perfect fit

Original replacement jaw crusher parts ensure the proper fit, form and function to reduce maintenance issues and increase longevity. Metso has a complete offering for both standard and engineered-to-order parts, ensuring you have the availability and support required. Our global distribution and logistics network ensures that Metso OEM spare and wear parts are available for whenever you need them.

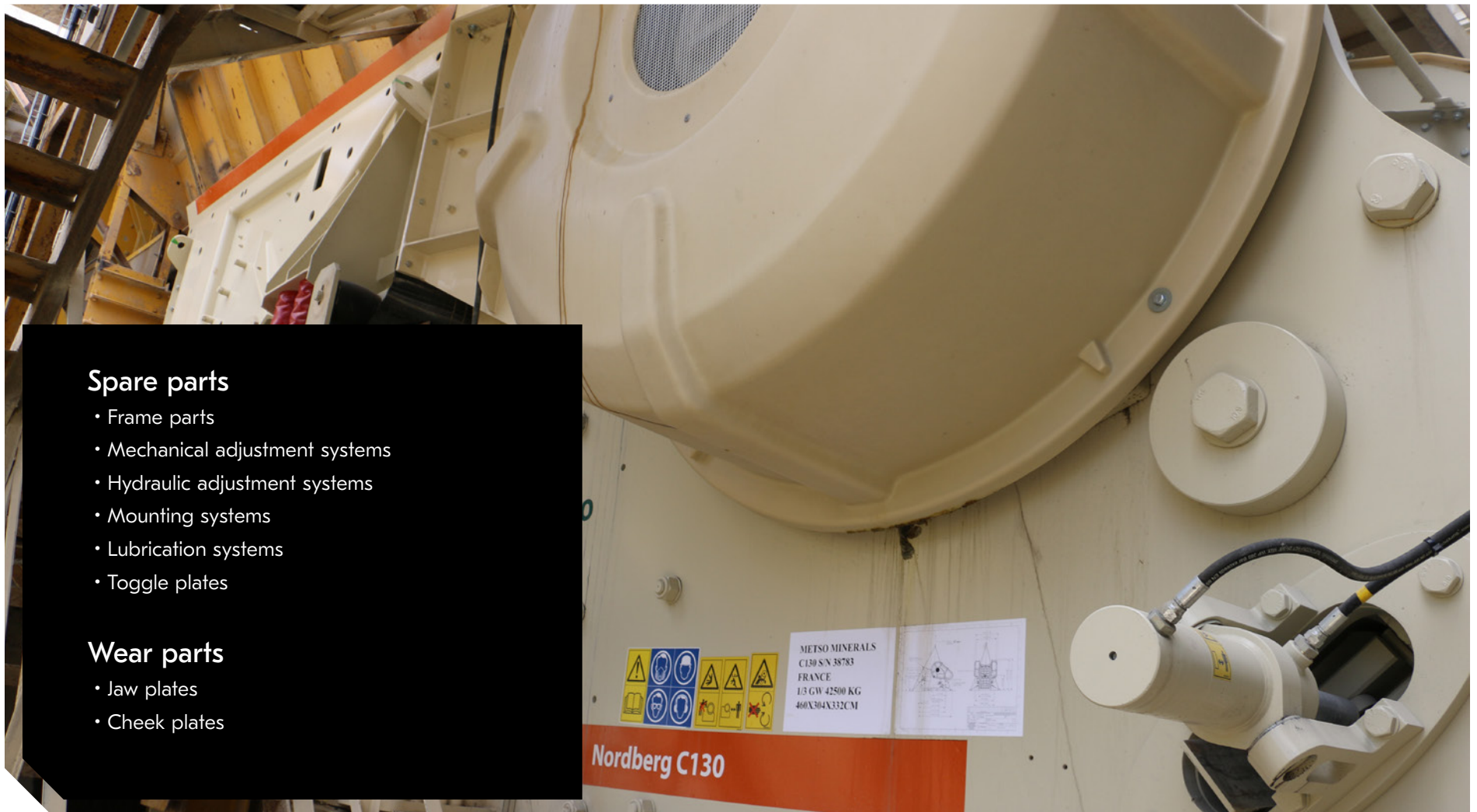

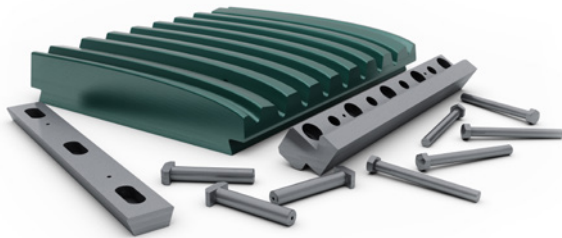

Helpful service tools

All Nordberg C Series jaw crushers are delivered with safe-to-use lifting tools for daily maintenance tasks. This includes a maintenance platform to make changing and rotating wear parts safer, quicker and even more ergonomic. Lifting tools for jaw dies, cheek plates and toggle plate are all part of the standard delivery from Metso.

Maximize your jaw crusher's efficiency, availability and longevity

Metso offers a full portfolio of services from maintenance, equipment upgrades and retrofits, process optimization and controls, all the way to Life Cycle Services. This ensures that you get the best out of your jaw crusher and reach your production goals, all whilst maximizing your jaw crusher's lifetime. You can be sure that our experts are always there to help you - at every step of the way!

Case story: Longcliffe Quarries Limited, UK



Improved operational efficiency and reliability with a Nordberg C160 jaw crusher

Longcliffe Quarries Ltd, produce specialty high-quality calcium carbonate products at their Brassington Moor Quarry. To meet their long-term objectives they decided to replace their existing primary crusher with a Nordberg C160 jaw crusher. The new crusher was installed into the existing space, respecting the feed and conveyor system. This was possible thanks to the modular design of the C160, which enabled it to be built in the final location. The new crusher justified the capex investment with improved production and throughput. And it also reduced downtime and improved operational efficiency and reliability.

Results:

- Improved throughput
- Impressive ability to crush marginal stones the size of the crusher mouth
- Reduction in downtime and in use of the hydraulic breaker
- Reduced downtime adjusting the crusher setting by using the hydraulic setting equipment
- Improved maintenance with the auto lubrication system, the compact design of the machine and easy access to partstones* due to reduced shut-down durations.

Case story: Albchrome, Burrel, Albania



Demanding ferrochrome crushing using Nordberg C Series C120 and C96

Albachrome crushes demanding plates of ferrochrome using Nordberg C Series C120 and C96 jaw crushers at their plant in Burrel, Albania. The C120 is operated as a primary crusher followed by the C96 as a secondary crusher in a closed circuit producing -50 mm material.

Due to the extra hard and highly abrasive feed material, the stationary plant and the operation had to be designed so that the material could be processed and crushed as efficiently as possible. They decided to equip the jaw crushers with Active Setting Control (ASC) technology to protect them from damage caused by the types of uncrushable objects common in crushing applications with ferrochrome-like feed material.

All Nordberg products are supported through Metso and through our network of authorized Metso distributors with our expert service, technical support and genuine Metso spare parts.

Metso is a frontrunner in sustainable technologies, end-to-end solutions and services for the aggregates, minerals processing and metals refining industries globally. We improve our customers' energy and water efficiency, increase their productivity, and reduce environmental risks with our product and service expertise. We are the partner for positive change.

metso.com

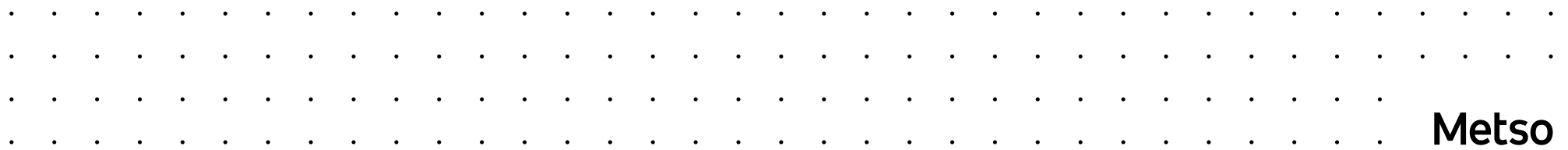

Metso